

# ヒーティングジャケット用 温度コントロール盤



Feb.2019



ラックデザイン

# 標準 コントロール盤 10~14 PID

- 8 ~ 14 PIDまでは、このサイズにて可能
- BOXサイズ 500X600X250(mm)
- 断線警報、ブザー、ランプ付

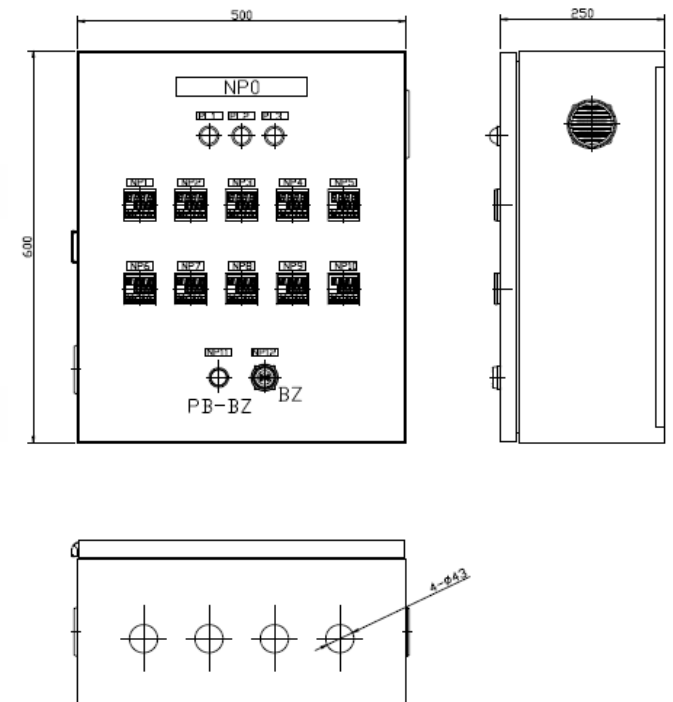

# 標準 8~6 PID 制御盤

- BOXサイズ 500X500X250(mm)
- 断線警報、ブザー、ランプ付

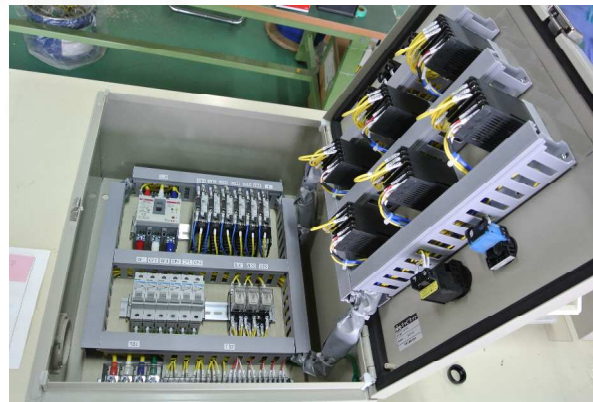

Feb.2019



ラックデザイン

# 標準 4 PID 制御盤

- BOXサイズ 400X400X250(mm)
- 断線警報、ブザー、ランプ付



# 個別 PID装置

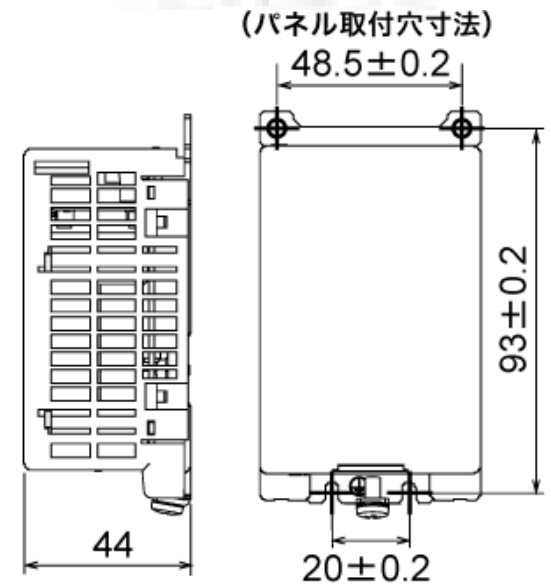
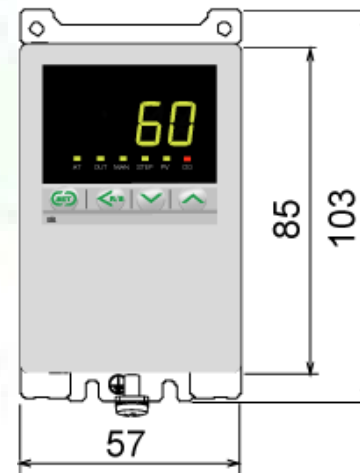
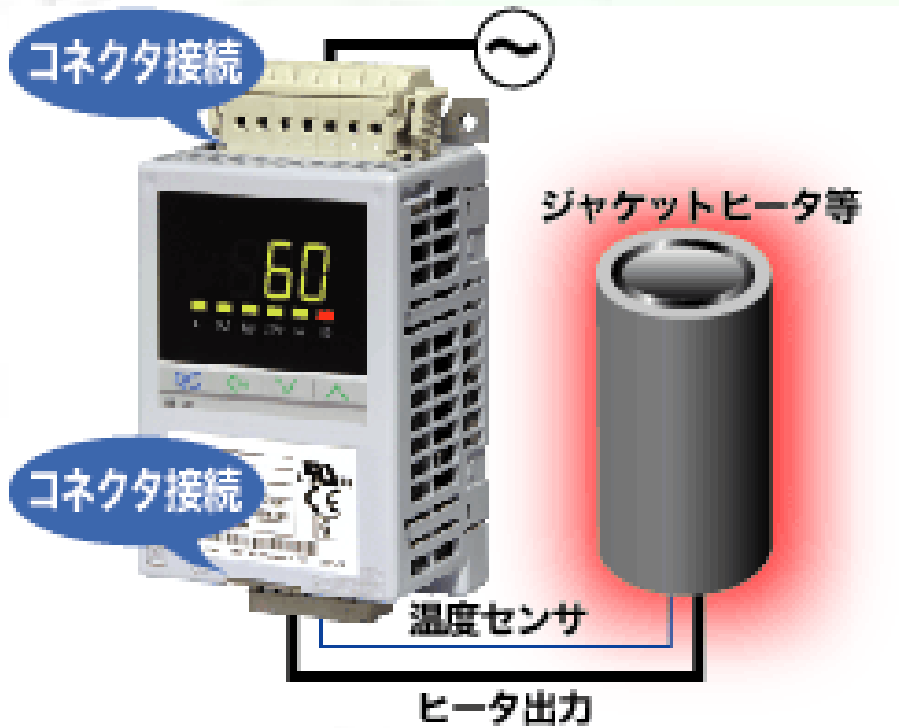

推奨ネジサイズ:M3  
(呼び長さ 6mm以上)



# 小型温度コントロール盤 1PID 2PID

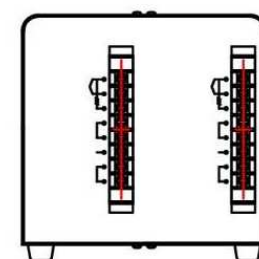
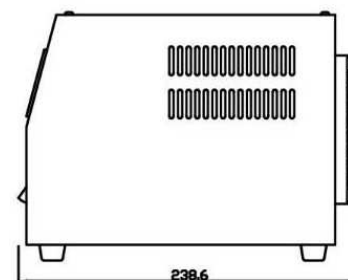
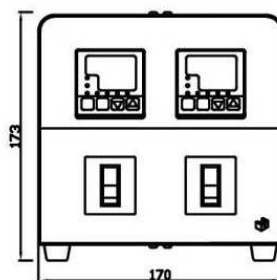
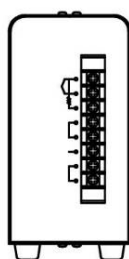
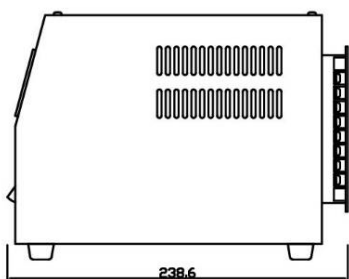
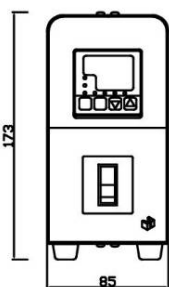
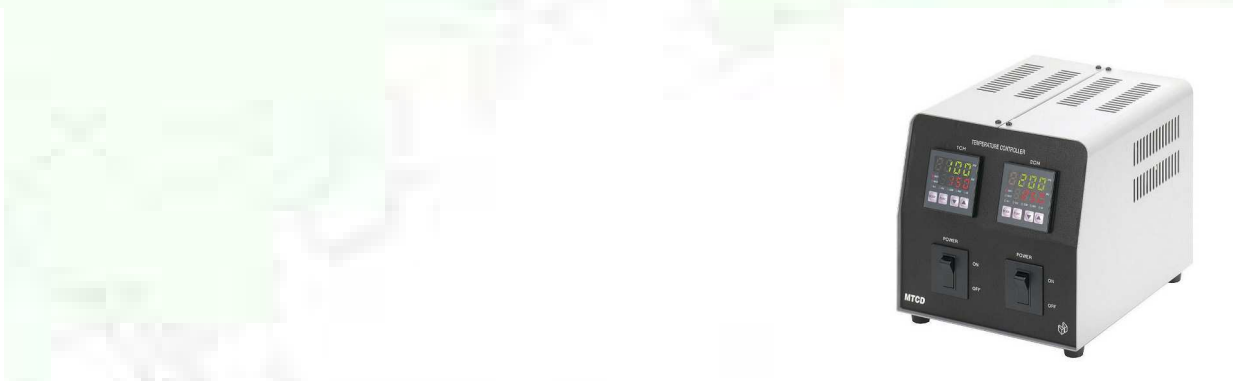

Feb.2019



ラックデザイン